

Digital controller with defrost and fans management
XR70CX

1. GENERAL WARNING

1.1 PLEASE READ BEFORE USING THIS MANUAL

- This manual is part of the product and should be kept near the instrument for easy and quick reference.
- The instrument shall not be used for purposes different from those described hereunder. It cannot be used as a safety device.
- Check the application limits before proceeding.

1.2 SAFETY PRECAUTIONS

- Check the supply voltage is correct before connecting the instrument.
- Do not expose to water or moisture: use the controller only within the operating limits avoiding sudden temperature changes with high atmospheric humidity to prevent formation of condensation
- Warning: disconnect all electrical connections before any kind of maintenance.
- Fit the probe where it is not accessible by the End User. The instrument must not be opened.
- In case of failure or faulty operation send the instrument back to the distributor or to "Dixell S.p.A." (see address) with a detailed description of the fault.
- Consider the maximum current which can be applied to each relay (see Technical Data).
- Ensure that the wires for probes, loads and the power supply are separated and far enough from each other, without crossing or intertwining.
- In case of applications in industrial environments, the use of mains filters (our mod. FT1) in parallel with inductive loads could be useful.

2. GENERAL DESCRIPTION

Model **XR70CX**, format 32 x 74 mm, is microprocessor based controller, suitable for applications on medium or low temperature ventilated refrigerating units. It has four relay outputs to control compressor, fan, and defrost, which can be either electrical or reverse cycle (hot gas). The last one can be used as light, for alarm signalling or as auxiliary output. It's provided with a Real Time Clock which allows programming of up to 6 daily defrost cycles, divided into holidays and workdays. A "Day and Night" function with two different set points is fitted for energy saving. It is also provided with up to four NTC or PTC probe inputs, the first one for temperature control, the second one, to be located onto the evaporator, to control the defrost termination temperature and to managed the fan. The digital input can operate as third temperature probe. The fourth one, to connect to the HOT KEY terminals is used to signal the condenser temperature alarm or to display a temperature.. The HOT KEY output allows to connect the unit, by means of the external module XJ485-CX, to a network line ModBUS-RTU compatible such as the **dixell** monitoring units of X-WEB family. It allows to program the controller by means the HOT KEY programming keyboard. The instrument is fully configurable through special parameters that can be easily programmed through the keyboard.

3. CONTROLLING LOADS

3.1 COMPRESSOR

The regulation is performed according to the temperature measured by the thermostat probe with a positive differential from the set point: if the temperature increases and reaches set point plus differential the compressor is started and then turned off when the temperature reaches the set point value again.

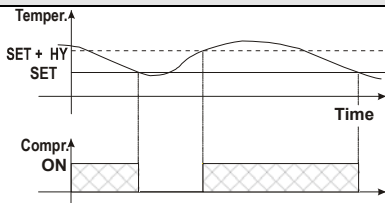

In case of fault in the thermostat probe the start and stop of the compressor are timed through parameters "CO_n" and "CO_F".

3.2 DEFROST

Two defrost modes are available through the "tdF" parameter: defrost through electrical heater (tdF = EL) and hot gas defrost (tdF = in). The defrost interval is controlled by means of parameter "EdF":
 - with EdF=in the defrost is made every "ldF" time,
 - with EdF = "rtc", the defrost is made in real time depending on the hours set in the parameters Ld1...Ld6 on workdays and in Sd1...Sd6 in holidays;

Other parameters are used to control defrost cycles: its maximum length (MdF) and two defrost modes: timed or controlled by the evaporator's probe (P2P).

At the end of defrost dripping time is started, its length is set in the Fdt parameter. With Fdt =0 the dripping time is disabled.

3.3 CONTROL OF EVAPORATOR FANS

The fan control mode is selected by means of the "FnC" parameter:
FnC = C_n: fans will switch ON and OFF with the compressor and **not run** during defrost;
FnC = o_n: fans will run even if the compressor is off, and not run during defrost;
 After defrost, there is a timed fan delay allowing for drip time, set by means of the "Fnd" parameter.
FnC = C_Y: fans will switch ON and OFF with the compressor and **run** during defrost;
FnC = o_Y: fans will run continuously also during defrost

An additional parameter "FSI" provides the setting of temperature, detected by the evaporator probe, above which the fans are always OFF. This is used to make sure circulation of air only if his temperature is lower than set in "FSI".

3.3.1 Forced activation of fans
 This function managed by the Fct parameter is designed to avoid short cycles of fans, that could happen when the controller is switched on or after a defrost, when the room air warms the evaporator. **Functioning**: if the difference of temperature between the evaporator and the room probes is more than the value of the Fct parameter, the fans are switched on. With Fct=0 the function is disabled.

3.3.2 Cyclical activation of the fans with compressor off.
 When FnC = c-n or c-Y (fans in parallel to the compressor), by means of the Fon and FoF parameters the fans can carry out on and off cycles even if the compressor is switched off. When the compressor is stopped the fans go on working for the Fon time. With Fon =0 the fans remain always off, when the compressor is off.

4. FRONT PANEL COMMANDS



SET: To display target set point; in programming mode it selects a parameter or confirm an operation.

(DEF) To start a manual defrost

(UP): To see the max. stored temperature; in programming mode it browses the parameter codes or increases the displayed value.

(DOWN) To see the min stored temperature; in programming mode it browses the parameter codes or decreases the displayed value.

To switch the instrument off, if oN = oFF.

To switch the light, if oA3 = Lig.

KEY COMBINATIONS:

To lock & unlock the keyboard.

SET + To enter in programming mode.

SET + To return to the room temperature display.

4.1 USE OF LEDS

Each LED function is described in the following table.

LED	MODE	FUNCTION
	ON	Compressor enabled
	Flashing	Anti-short cycle delay enabled
	ON	Defrost enabled
	Flashing	Drip time in progress
	ON	Fans enabled
	Flashing	Fans delay after defrost in progress.
	ON	An alarm is occurring
	ON	Continuous cycle is running
	ON	Energy saving enabled
	ON	Light on
	ON	Auxiliary relay on
	ON	Measurement unit
	Flashing	Programming phase

5. MAX & MIN TEMPERATURE MEMORIZATION

5.1 HOW TO SEE THE MIN TEMPERATURE

1. Press and release the key.
2. The "Lo" message will be displayed followed by the minimum temperature recorded.
3. By pressing the key again or by waiting 5s the normal display will be restored.

5.2 HOW TO SEE THE MAX TEMPERATURE

1. Press and release the key.
2. The "Hi" message will be displayed followed by the maximum temperature recorded.
3. By pressing the key again or by waiting 5s the normal display will be restored.

5.3 HOW TO RESET THE MAX AND MIN TEMPERATURE RECORDED

1. Hold press the SET key for more than 3s, while the max. or min temperature is displayed. (rSt message will be displayed)
2. To confirm the operation the "rSt" message starts blinking and the normal temperature will be displayed.

6. MAIN FUNCTIONS

6.1 TO SET THE CURRENT TIME AND DAY

When the instrument is switched on, it's necessary to program the time and day.

1. Enter the Pr1 programming menu, by pushing the SET + keys for 3s.
2. The rtc parameter is displayed. Push the SET key to enter the real time clock menu.
3. The Hur (hour) parameter is displayed.
4. Push the SET and set current hour by the UP and Down keys, then push SET to confirm the value..
5. Repeat the same operations on the Min (minutes) and dAY (day) parameters.

To exit: Push SET+UP keys or wait for 15 secs without pushing any keys.

6.2 HOW TO SEE THE SETPOINT

-  1. Push and immediately release the **SET** key: the display will show the Set point value;
2. Push and immediately release the **SET** key or wait for 5 seconds to display the probe value again.

6.3 HOW TO CHANGE THE SETPOINT

1. Push the **SET** key for more than 2 seconds to change the Set point value;
2. The value of the set point will be displayed and the "°C" or "°F" LED starts blinking;
3. To change the Set value push the **▲** or **▼** arrows within 10s.
4. To memorise the new set point value push the **SET** key again or wait 10s.

6.4 HOW TO START A MANUAL DEFROST

 Push the **DEF** key for more than 2 seconds and a manual defrost will start.

6.5 HOW TO CHANGE A PARAMETER VALUE

- To change the parameter's value operate as follows:
1. Enter the Programming mode by pressing the **Set + ▼** keys for 3s (the "°C" or "°F" LED starts blinking).
 2. Select the required parameter. Press the "**SET**" key to display its value
 3. Use "**UP**" or "**DOWN**" to change its value.
 4. Press "**SET**" to store the new value and move to the following parameter.
- To exit:** Press **SET + UP** or wait 15s without pressing a key.
- NOTE:** the set value is stored even when the procedure is exited by waiting the time-out to expire.

6.6 THE HIDDEN MENU

The hidden menu Includes all the parameters of the instrument.

6.6.1 HOW TO ENTER THE HIDDEN MENU

1. Enter the Programming mode by pressing the **Set + ▼** keys for 3s (the "°C" or "°F" LED starts blinking).
 2. Released the keys, then push again the **Set+ ▼** keys for more than 7s. The Pr2 label will be displayed immediately followed from the HY parameter.
- NOW YOU ARE IN THE HIDDEN MENU.**
3. Select the required parameter.
 4. Press the "**SET**" key to display its value
 5. Use **▲** or **▼** to change its value.
 6. Press "**SET**" to store the new value and move to the following parameter.
- To exit:** Press **SET + ▲** or wait 15s without pressing a key.
- NOTE1:** if none parameter is present in Pr1, after 3s the "noP" message is displayed. Keep the keys pushed till the Pr2 message is displayed.
- NOTE2:** the set value is stored even when the procedure is exited by waiting the time-out to expire.

6.6.2 HOW TO MOVE A PARAMETER FROM THE HIDDEN MENU TO THE FIRST LEVEL AND VICEVERSA.

Each parameter present in the HIDDEN MENU can be removed or put into "THE FIRST LEVEL" (user level) by pressing "**SET + ▼**".

In HIDDEN MENU when a parameter is present in First Level the decimal point is on.

6.7 HOW TO LOCK THE KEYBOARD

1. Keep pressed for more than 3 s the **UP + DOWN** keys.
2. The "POF" message will be displayed and the keyboard will be locked. At this point it will be possible only to see the set point or the MAX o Min temperature stored
3. If a key is pressed more than 3s the "POF" message will be displayed.

6.8 TO UNLOCK THE KEYBOARD

Keep pressed together for more than 3s the **▲** and **▼** keys, till the "Pon" message will be displayed.

6.9 THE CONTINUOUS CYCLE

When defrost is not in progress, it can be activated by holding the "**▲**" key pressed for about 3 seconds. The compressor operates to maintain the "ccS" set point for the time set through the "CCt" parameter. The cycle can be terminated before the end of the set time using the same activation key "**▲**" for 3 seconds.

6.10 THE ON/OFF FUNCTION

 With "onF = oFF", pushing the **ON/OFF** key, the instrument is switched off. The "OFF" message is displayed. In this configuration, the regulation is disabled.

To switch the instrument on, push again the **ON/OFF** key.

WARNING: Loads connected to the normally closed contacts of the relays are always supplied and under voltage, even if the instrument is in stand by mode.

7. PARAMETERS

rtc Real time clock menu: to set the time and date and defrost start time.

REGULATION

- Hy Differential:** (0,1 ÷ 25,5°C / 1÷255 °F) Intervention differential for set point. Compressor Cut IN is Set Point + differential (Hy). Compressor Cut OUT is when the temperature reaches the set point.
- LS Minimum set point:** (-50°C+SET/-58°F+SET): Sets the minimum value for the set point.
- US Maximum set point:** (SET+110°C/SET+230°F). Set the maximum value for set point.
- Ot Thermostat probe calibration:** (-12,0÷12,0°C; -120÷120°F) allows to adjust possible offset of the thermostat probe.
- P2P Evaporator probe presence:** n= not present: the defrost stops by time; y= present: the defrost stops by temperature.
- OE Evaporator probe calibration:** (-12,0÷12,0°C; -120÷120°F). allows to adjust possible offset of the evaporator probe.

- P3P Third probe presence (P3):** n= not present; the terminal operates as digital input; y= present; the terminal operates as third probe.
- O3 Third probe calibration (P3):** (-12,0÷12,0°C; -120÷120°F). allows to adjust possible offset of the third probe.
- P4P Fourth probe presence:** (n = Not present; y = present).
- o4 Fourth probe calibration:** (-12,0÷12,0°C) allows to adjust possible offset of the fourth probe.
- OdS Outputs activation delay at start up:** (0÷255min) This function is enabled at the initial start up of the instrument and inhibits any output activation for the period of time set in the parameter.
- AC Anti-short cycle delay:** (0÷50 min) minimum interval between the compressor stop and the following restart.
- rtr Percentage of the second and first probe for regulation (0÷100; 100 = P1, 0 = P2):** it allows to set the regulation according to the percentage of the first and second probe, as for the following formula (rtr(P1-P2)/100 + P2).
- CCt Compressor ON time during continuous cycle:** (0,0÷24,0h; res. 10min) Allows to set the length of the continuous cycle: compressor stays on without interruption for the CCt time. Can be used, for instance, when the room is filled with new products.
- CCS Set point for continuous cycle:** (-50÷150°C) it sets the set point used during the continuous cycle.
- COon Compressor ON time with faulty probe:** (0÷255 min) time during which the compressor is active in case of faulty thermostat probe. With COon=0 compressor is always OFF.
- COF Compressor OFF time with faulty probe:** (0÷255 min) time during which the compressor is OFF in case of faulty thermostat probe. With COF=0 compressor is always active.

DISPLAY

- CF Temperature measurement unit:** °C=Celsius; °F=Fahrenheit. **WARNING:** When the measurement unit is changed the SET point and the values of the parameters Hy, LS, US, Ot, ALU and ALL have to be checked and modified if necessary).
- rES Resolution (for °C):** (in = 1°C; dE = 0.1 °C) allows decimal point display.
- Lod Instrument display:** (P1; P2, P3, P4, SET, dtr): it selects which probe is displayed by the instrument: **P1** = Thermostat probe; **P2** = Evaporator probe; **P3** = Third probe(only for model with this option enabled); **P4** = Fourth probe, **SET** = set point; **dtr** = percentage of visualization.
- rEd X- REP display (optional):** (P1; P2, P3, P4, SET, dtr): it selects which probe is displayed by X- REP: **P1** = Thermostat probe; **P2** = Evaporator probe; **P3** = Third probe(only for model with this option enabled); **P4** = Fourth probe, **SET** = set point; **dtr** = percentage of visualization.
- dLy Display delay:** (0 ÷20,0m; risul. 10s) when the temperature increases, the display is updated of 1 °C/1°F after this time.
- dtr Percentage of the second and first probe for visualization when Lod = dtr (0÷100; 100 = P1, 0 = P2):** if **Lod = dtr** it allows to set the visualization according to the percentage of the first and second probe, as for the following formula (dtr(P1-P2)/100 + P2).

DEFROST

- EdF Defrost mode:**
- rtc = Real Time Clock mode.** Defrost time follows **Ld1+Ld6** parameters on workdays and **Sd1+Sd6** on holidays.
- in = interval mode.** The defrost starts when the time "ldf" is expired.
- dFP Probe selection for defrost termination:** nP = no probe; **P1** =thermostat probe; **P2** = evaporator probe; **P3** =configurable probe; **P4** = Probe on Hot Key plug.
- tdF Defrost type:** EL = electrical heater; in = hot gas
- dTE Defrost termination temperature:** (-50+50 °C/ -58÷122°F) (Enabled only when EdF=Pb) sets the temperature measured by the evaporator probe, which causes the end of defrost.
- ldF Interval between defrost cycles:** (0÷120h) Determines the time interval between the beginning of two defrost cycles.
- MdF (Maximum) length for defrost:** (0÷255min) When **P2P = n**, (not evaporator probe: timed defrost) it sets the defrost duration, when **P2P = y** (defrost end based on temperature) it sets the maximum length for defrost.
- dSd Start defrost delay:** (0÷99min) This is useful when different defrost start times are necessary to avoid overloading the plant.
- dFd Temperature displayed during defrost:** (rt = real temperature; it = temperature at defrost start; SEt = set point; dEF = "dEF" label)
- dAd MAX display delay after defrost:** (0÷255min). Sets the maximum time between the end of defrost and the restarting of the real room temperature display.
- Fdt Drip time:** (0÷120 min) time interval between reaching defrost termination temperature and the restoring of the control's normal operation. This time allows the evaporator to eliminate water drops that might have formed due to defrost.
- dPo First defrost after start-up:** (y = immediately; n = after the ldf time)
- dAF Defrost delay after continuous cycle:** (0÷23,5h) time interval between the end of the fast freezing cycle and the following defrost related to it.

FANS

- FnC Fans operating mode:** C-n= runs with the compressor, OFF during defrost;
- o-n** = continuous mode, OFF during defrost;
- C-Y** = runs with the compressor, ON during defrost;
- o-Y** = continuous mode, ON during defrost;
- Fnd Fans delay after defrost:** (0÷255min) Interval between end of defrost and evaporator fans start.
- Fct Temperature differential avoiding short cycles of fans** (0÷59°C; Fct=0 function disabled). If the difference of temperature between the evaporator and the room probes is more than the value of the Fct parameter, the fans are switched on.
- FSt Fans stop temperature:** (-50÷50°C/122°F) setting of temperature, detected by evaporator probe, above which fans are always OFF.
- Fon Fan ON time:** (0÷15 min) with Fnc = C_n or C_y, (fan activated in parallel with compressor). it sets the evaporator fan ON cycling time when the compressor is off. With Fon =0 and FoF ≠ 0 the fan are always off, with Fon=0 and FoF =0 the fan are always off.
- FoF Fan OFF time:** (0÷15 min) with Fnc = C_n or C_y, (fan activated in parallel with compressor). it sets the evaporator fan off cycling time when the compressor is off. With Fon =0 and FoF ≠ 0 the fan are always off, with Fon=0 and FoF =0 the fan are always off.
- FAP Probe selection for fan management:** nP = no probe; **P1** =thermostat probe; **P2** = evaporator probe; **P3** =configurable probe; **P4** = Probe on Hot Key plug.

ALARMS

ALC Temperature alarms configuration: (Ab; rE)

Ab= absolute temperature: alarm temperature is given by the ALL or ALU values. rE = temperature alarms are referred to the set point. Temperature alarm is enabled when the temperature exceeds the "SET+ALU" or "SET-ALL" values.

- ALU** **MAXIMUM temperature alarm:** (SET+110°C; SET+230°F) when this temperature is reached the alarm is enabled, after the "ALD" delay time.
- ALL** **Minimum temperature alarm:** (-50.0 ÷ SET°C; -58÷230°F) when this temperature is reached the alarm is enabled, after the "ALD" delay time.
- AFH** **Differential for temperature alarm/ fan recovery:** (0,1÷25,5°C; 1÷45°F) Intervention differential for recovery of temperature alarm. It's also used for the restart of the fan when the FSt temperature is reached
- ALd** **Temperature alarm delay:** (0÷255 min) time interval between the detection of an alarm condition and alarm signalling.
- dAO** **Exclusion of temperature alarm at startup:** (from 0.0 min to 23.5h) time interval between the detection of the temperature alarm condition after instrument power on and alarm signalling.

CONDENSER TEMPERATURE ALARM

- AP2** **Probe selection for temperature alarm of condenser:** nP = no probe; P1 = thermostat probe; P2 = evaporator probe; P3 =configurable probe; P4 = Probe on Hot Key plug.
- AL2** **Low temperature alarm of condenser:** (-55÷150°C) when this temperature is reached the LA2 alarm is signalled, possibly after the Ad2 delay.
- Au2** **High temperature alarm of condenser:** (-55÷150°C) when this temperature is reached the HA2 alarm is signalled, possibly after the Ad2 delay.
- AH2** **Differential for temperature condenser alarm recovery:** (0,1÷25,5°C; 1÷45°F)
- Ad2** **Condenser temperature alarm delay:** (0÷255 min) time interval between the detection of the condenser alarm condition and alarm signalling.
- dA2** **Condenser temperature alarm exclusion at start up:** (from 0.0 min to 23.5h, res. 10min)
- bLL** **Compressor off with low temperature alarm of condenser:** n = no: compressor keeps on working; Y = yes, compressor is switched off till the alarm is present, in any case regulation restarts after AC time at minimum.
- AC2** **Compressor off with high temperature alarm of condenser:** n = no: compressor keeps on working; Y = yes, compressor is switched off till the alarm is present, in any case regulation restarts after AC time at minimum.

FOURTH RELAY

- tbA** **Alarm relay silencing (with oA3=ALR):**
n= silencing disabled: alarm relay stays on till alarm condition lasts,
y=silencing enabled: alarm relay is switched OFF by pressing a key during an alarm
- oA3** **Fourth relay configuration:** ALr: alarm; Lig: light; AuS: Auxiliary relay; onF: always on with instrument on; db = do not select it; dEF: do not select it!; FAN: do not select it!; dF2: do not select it.
- AoP** **Alarm relay polarity:** it set if the alarm relay is open or closed when an alarm happens. CL= terminals 1-2 closed during an alarm; oP = terminals 1-2 open during an alarm

DIGITAL INPUT

- i1P** **Digital input polarity:** oP: the digital input is activated by opening the contact; CL: the digital input is activated by closing the contact.
- i1F** **Digital input configuration:** EAL = external alarm: "EA" message is displayed; bAL = serious alarm "CA" message is displayed. PAL = pressure switch alarm, "CA" message is displayed; dor = door switch function; dEF = activation of a defrost cycle; AUS =not enabled; Htr = kind of action inversion (cooling – heating); FAN = not set it; ES = Energy saving.
- did:** (0÷255 min) with i1F= EAL or i1F = bAL **digital input alarm delay:** delay between the detection of the external alarm condition and its signalling.
with i1F= dor: **door open signalling delay**
with i1F = PAL: **time for pressure switch function:** time interval to calculate the number of the pressure switch activation.
- nPS** **Pressure switch number:** (0 ÷15) Number of activation of the pressure switch, during the "did" interval, before signalling the alarm event (i2F= PAL).
If the nPS activation in the did time is reached, **switch off and on the instrument to restart normal regulation.**
- odc** **Compressor and fan status when open door:** no = normal; Fan = Fan OFF; CPr = Compressor OFF; F_C = Compressor and fan OFF.
- rrd** **Outputs restart after doA alarm:** no = outputs not affected by the doA alarm; yES = outputs restart with the doA alarm;
- HES** **Temperature increase during the Energy Saving cycle :** (-30,0°C÷30,0°C/22÷86°F) it sets the increasing value of the set point during the Energy Saving cycle.

TO SET CURRENT TIME AND WEEKLY HOLIDAYS

- Hur** **Current hour** (0 ÷ 23 h)
- Min** **Current minute** (0 ÷ 59min)
- dAY** **Current day** (Sun ÷ SAst)
- Hd1** **First weekly holiday** (Sun ÷ nu) Set the first day of the week which follows the holiday times.
- Hd2** **Second weekly holiday** (Sun ÷ nu) Set the second day of the week which follows the holiday times.
- N.B.** Hd1,Hd2 can be set also as "nu" value (Not Used).

TO SET ENERGY SAVING TIMES

- ILE** **Energy Saving cycle start during workdays:** (0 ÷ 23h 50 min.) During the Energy Saving cycle the set point is increased by the value in HES so that the operation set point is SET + HES.
- dLE** **Energy Saving cycle length during workdays:** (0 ÷ 24h 00 min.) Sets the duration of the Energy Saving cycle on workdays.
- ISE** **Energy Saving cycle start on holidays.** (0 ÷ 23h 50 min.)
- dSE** **Energy Saving cycle length on holidays** (0 ÷ 24h 00 min.)

TO SET DEFROST TIMES

- Ld1+Ld6** **Workday defrost start** (0 ÷ 23h 50 min.) These parameters set the beginning of the 6 programmable defrost cycles during workdays. Ex. When Ld2 = 12.4 the second defrost starts at 12.40 during workdays.
- Sd1+Sd6** **Holiday defrost start** (0 ÷ 23h 50 min.) These parameters set the beginning of the 6 programmable defrost cycles on holidays. Ex. When Sd2 = 3.4 the second defrost starts at 3.40 on holidays.
N.B. :To disable a defrost cycle set it to "nu"(not used). Ex. If Ld6=nu ; the sixth defrost cycle is disabled

OTHER

- Adr** **Serial address** (1÷244): Identifies the instrument address when connected to a ModBUS compatible monitoring system.

PbC **Type of probe:** it allows to set the kind of probe used by the instrument: PbC = PBC probe, ntc = NTC probe.

onF **on/off key enabling:** nu = disabled; oFF = enabled; ES = not set it.

dP1 **Thermostat probe display**

dP2 **Evaporator probe display**

dP3 **Third probe display- optional.**

dP4 **Fourth probe display.**

rSE **Real set point:** it shows the set point used during the energy saving cycle or during the continuous cycle.

rEL **Software release** for internal use.

Ptb **Parameter table code:** readable only.

8. DIGITAL INPUT (ENABLED WITH P3P = N)

The free voltage digital input is programmable in different configurations by the "i1F" parameter.

8.1 DOOR SWITCH INPUT (i1F = dor)

It signals the door status and the corresponding relay output status through the "odc" parameter: no = normal (any change); Fan = Fan OFF; CPr = Compressor OFF; F_C = Compressor and fan OFF. Since the door is opened, after the delay time set through parameter "did", the door alarm is enabled, the display shows the message "dA" and the regulation restarts is rtr = yES. The alarm stops as soon as the external digital input is disabled again. With the door open, the high and low temperature alarms are disabled.

8.2 GENERIC ALARM (i1F = EAL)

As soon as the digital input is activated the unit will wait for "did" time delay before signalling the "EAL" alarm message. The outputs status don't change. The alarm stops just after the digital input is de-activated.

8.3 SERIOUS ALARM MODE (i1F = bAL)

When the digital input is activated, the unit will wait for "did" delay before signalling the "CA" alarm message. The relay outputs are switched OFF. The alarm will stop as soon as the digital input is de-activated.

8.4 PRESSURE SWITCH (i1F = PAL)

If during the interval time set by "did" parameter, the pressure switch has reached the number of activation of the "nPS" parameter, the "CA" pressure alarm message will be displayed. The compressor and the regulation are stopped. When the digital input is ON the compressor is always OFF. If the nPS activation in the did time is reached, **switch off and on the instrument to restart normal regulation.**

8.5 START DEFROST (i1F = dFr)

It starts a defrost if there are the right conditions. After the defrost is finished, the normal regulation will restart only if the digital input is disabled otherwise the instrument will wait until the "MdF" safety time is expired.

8.6 INVERSION OF THE KIND OF ACTION: HEATING-COOLING (i1F = Htr)

This function allows to invert the regulation of the controller: from cooling to heating and viceversa.

8.7 ENERGY SAVING (i1F = ES)

The Energy Saving function allows to change the set point value as the result of the SET+ HES (parameter) sum. This function is enabled until the digital input is activated.

8.8 DIGITAL INPUTS POLARITY

The digital input polarity depends on the "i1P" parameter.

i1P=CL: the input is activated by closing the contact.

i1P=OP: the input is activated by opening the contact

9. TTL SERIAL LINE – FOR MONITORING SYSTEMS

The TTL serial line, available through the HOT KEY connector, allows by means of the external TTL/RS485 converter, XJ485-CX, to connect the instrument to a monitoring system ModBUS-RTU compatible such as the X-WEB500/3000/300.

10. X-REP OUTPUT – OPTIONAL

As optional, an X-REP can be connected to the instrument, through the HOY KEY connector. The X-REP output EXCLUDES the serial connection.



To connect the X-REP to the instrument the following connectors must be used CAB-51F(1m), CAB-52F(2m), CAB-55F(5m),

11. INSTALLATION AND MOUNTING

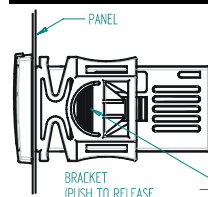

Instrument XR70CX shall be mounted on vertical panel, in a 29x71 mm hole, and fixed using the special bracket supplied.

The temperature range allowed for correct operation is 0÷60 °C. Avoid places subject to strong vibrations, corrosive gases, excessive dirt or humidity. The same recommendations apply to probes. Let air circulate by the cooling holes.

12. ELECTRICAL CONNECTIONS

The instrument is provided with screw terminal block to connect cables with a cross section up to 2,5 mm². Before connecting cables make sure the power supply complies with the instrument's requirements. Separate the probe cables from the power supply cables, from the outputs and the power connections. Do not exceed the maximum current allowed on each relay, in case of heavier loads use a suitable external relay.

12.1 PROBE CONNECTION

The probes shall be mounted with the bulb upwards to prevent damages due to casual liquid infiltration. It is recommended to place the thermostat probe away from air streams to correctly measure the average room temperature. Place the defrost termination probe among the evaporator fins in the coldest place, where most ice is formed, far from heaters or from the warmest place during defrost, to prevent premature defrost termination.

13. HOW TO USE THE HOT KEY

13.1 HOW TO PROGRAM A HOT KEY FROM THE INSTRUMENT (UPLOAD)

1. Program one controller with the front keypad.
2. When the controller is ON, insert the "Hot key" and push \blacktriangle key; the "uPL" message appears followed a by flashing "End"
3. Push "SET" key and the End will stop flashing.
4. Turn OFF the instrument remove the "Hot Key", then turn it ON again.

NOTE: the "Err" message is displayed for failed programming. In this case push again \blacktriangle key if you want to restart the upload again or remove the "Hot key" to abort the operation.

13.2 HOW TO PROGRAM AN INSTRUMENT USING A HOT KEY (DOWNLOAD)

1. Turn OFF the instrument.
2. Insert a programmed "Hot Key" into the 5 PIN receptacle and then turn the Controller ON.
3. Automatically the parameter list of the "Hot Key" is downloaded into the Controller memory, the "doL" message is blinking followed a by flashing "End".
4. After 10 seconds the instrument will restart working with the new parameters.
5. Remove the "Hot Key".

NOTE the message "Err" is displayed for failed programming. In this case turn the unit off and then on if you want to restart the download again or remove the "Hot key" to abort the operation.

14. ALARM SIGNALS

Message	Cause	Outputs
"P1"	Room probe failure	Compressor output acc. to par. "Con" and "COF"
"P2"	Evaporator probe failure	Defrost end is timed
"P3"	Third probe failure	Outputs unchanged
"P4"	Fourth probe failure	Outputs unchanged
"HA"	Maximum temperature alarm	Outputs unchanged.
"LA"	Minimum temperature alarm	Outputs unchanged.
"HA2"	Condenser high temperature	It depends on the "Ac2" parameter
"LA2"	Condenser low temperature	It depends on the "bLL" parameter
"dA"	Door open	Compressor and fans restarts
"EA"	External alarm	Output unchanged.
"CA"	Serious external alarm (i1F=bAL)	All outputs OFF.
"CA"	Pressure switch alarm (i1F=PAL)	All outputs OFF
"rtc"	Real time clock alarm	Alarm output ON; Other outputs unchanged; Defrosts according to par. "ldF" Set real time clock has to be set
rtF	Real time clock board failure	Alarm output ON; Other outputs unchanged; Defrosts according to par. "ldF" Contact the service

14.1 ALARM RECOVERY

Probe alarms "P1", "P2", "P3" and "P4" start some seconds after the fault in the related probe; they automatically stop some seconds after the probe restarts normal operation. Check connections before replacing the probe.

Temperature alarms "HA", "LA", "HA2" and "LA2" automatically stop as soon as the temperature returns to normal values.

Alarms "EA" and "CA" (with i1F=bAL) recover as soon as the digital input is disabled.

Alarm "CA" (with i1F=PAL) recovers only by switching off and on the instrument.

14.2 OTHER MESSAGES

Pon	Keyboard unlocked.
PoF	Keyboard locked
noP	In programming mode: none parameter is present in Pr1 On the display or in dP2, dP3, dP4: the selected probe is nor enabled

15. TECHNICAL DATA

Housing: self extinguishing ABS.

Case: XR70CX frontal 32x74 mm; depth 60mm;

Mounting: XR70CX panel mounting in a 71x29mm panel cut-out

Protection: IP20; Frontal protection: XR70CX IP65

Connections: Screw terminal block $\leq 2,5 \text{ mm}^2$ wiring.

Power supply: according to the model: 12Vac/dc, $\pm 10\%$; 24Vac/dc, $\pm 10\%$; 230Vac $\pm 10\%$, 50/60Hz, 110Vac $\pm 10\%$, 50/60Hz

Power absorption: 3VA max

Display: 3 digits, red LED, 14,2 mm high; Inputs: Up to 4 NTC or PTC probes.

Digital input: free voltage contact

Relay outputs: compressor SPST 8(3) A, 250Vac; SPST 16(6)A 250Vac

defrost: SPDT 8(3) A, 250Vac or SPST 16(6)A 250Vac

fan: SPST 5A, 250Vac or SPST 16(6)A 250Vac

aux: SPDT 8(3) A, 250Vac or SPST 16(6)A 250Vac

Data storing: on the non-volatile memory (EEPROM).

Internal clock back-up: 24 hours

Kind of action: 1B; Pollution grade: 2; Software class: A.;

Rated impulsive voltage: 2500V; Overvoltage Category: II

Operating temperature: 0+60 °C; Storage temperature: -30+85 °C.

Relative humidity: 20+85% (no condensing)

Measuring and regulation range: NTC probe: -40+110°C (-40+230°F);

PTC probe: -50+150°C (-58+302°F)

Resolution: 0,1 °C or 1°C or 1 °F (selectable); Accuracy (ambient temp. 25°C): $\pm 0,7 \text{ °C} \pm 1 \text{ digit}$

16. CONNECTIONS

The X-REP output excludes the TTL output.. It's present in the following codes:

XR70CX- xx2xx, XR70CX -xx3xx;

16.1 XR70CX – 8A OR 16A COMP. RELAY - 12VAC/DV OR 24 VAC/DV

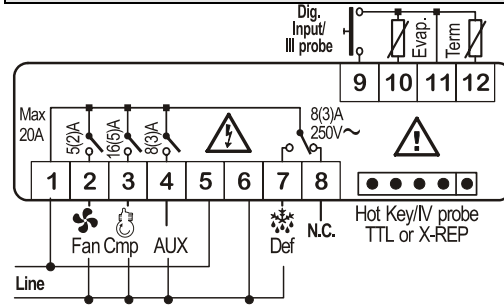

NOTE: The compressor relay is 8(3)A or 16(6)A according to the model.
24Vac/dc supply: connect to the terminals 5 and 6.

16.2 XR70CX –4 X 16A - 12VAC/DC

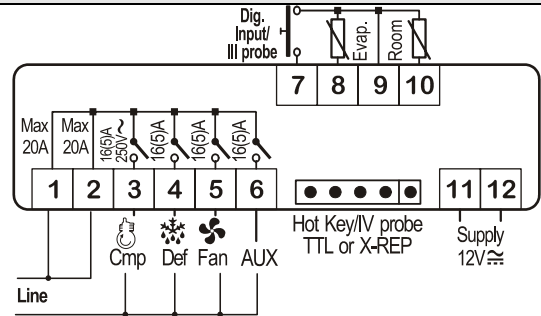

17. DEFAULT SETTING VALUES

Label	Name	Range	°C/°F	Level
Set	Set point	LS+US	-5.0	---
rtc	Real time clock menu	-	-	Pr1
Hy	Differential	0,1+25.5°C/1+ 255°F	2.0	Pr1
LS	Minimum set point	-50°C+SET/-58°F+SET	-50.0	Pr2
US	Maximum set point	SET+110°C/SET + 230°F	110	Pr2
Ot	Thermostat probe calibration	-12+12°C /-120+120°F	0.0	Pr1
P2P	Evaporator probe presence	n=not present; Y=pres.	Y	Pr1
OE	Evaporator probe calibration	-12+12°C /-120+120°F	0.0	Pr2
P3P	Third probe presence	n=not present; Y=pres.	n	Pr2
O3	Third probe calibration	-12+12°C /-120+120°F	0	Pr2
P4P	Fourth probe presence	n=not present; Y=pres.	n	Pr2
O4	Fourth probe calibration	-12+12°C /-120+120°F	0	Pr2
OdS	Outputs delay at start up	0+255 min	0	Pr2
AC	Anti-short cycle delay	0 + 50 min	1	Pr1
rtr	P1-P2 percentage for regulation	0 + 100 (100=P1, 0=P2)	100	Pr2
CCt	Continuous cycle duration	0.0+24.0h	0.0	Pr2
CCS	Set point for continuous cycle	(-55.0+150.0°C) (-67+302°F)	-5	Pr2
COn	Compressor ON time with faulty probe	0 + 255 min	15	Pr2
COF	Compressor OFF time with faulty probe	0 + 255 min	30	Pr2
CF	Temperature measurement unit	°C + °F	°C	Pr2
rES	Resolution	in=integer; dE= dec.point	dE	Pr1
LoD	Probe displayed	P1,P2	P1	Pr2
dEd	X-REP display	P1 - P2 - P3 - P4 - SET - dtr	P1	Pr2
dLy	Display temperature delay	0 + 20.0 min (10 sec.)	0	Pr2
dtr	P1-P2 percentage for displ	1 + 99	50	Pr2
tdF	Defrost type	EL=el. heater; in= hot gas	EL	Pr1
dFP	Probe selection for defrost termination	nP; P1; P2; P3; P4	P2	Pr2
dtE	Defrost termination temperature	-50 + 50 °C	8	Pr1
ldF	Interval between defrost cycles	1 + 120 ore	6	Pr1
MdF	(Maximum) length for defrost	0 + 255 min	30	Pr1
dSd	Start defrost delay	0+99min	0	Pr2
dFd	Displaying during defrost	rt, it, SET, DEF	it	Pr2
dAd	MAX display delay after defrost	0 + 255 min	30	Pr2
Fdt	Draining time	0+120 min	0	Pr2
dPo	First defrost after startup	n=after ldF; y=immed.	n	Pr2
dAF	Defrost delay after fast freezing	0 + 23h e 50'	0.0	Pr2
Fnc	Fan operating mode	C-n, o-n, C-y, o-y	o-n	Pr1
Fnd	Fan delay after defrost	0+255min	10	Pr1
Fct	Differential of temperature for forced activation of fans	0+50°C	10	Pr2
FSt	Fan stop temperature	-50+50°C/-58+122°F	2	Pr1
Fon	Fan on time with compressor off	0+15 (min.)	0	Pr2
FoF	Fan off time with compressor off	0+15 (min.)	0	Pr2
FAP	Probe selection for fan management	nP; P1; P2; P3; P4	P2	Pr2
ALc	Temperat. alarms configuration	rE= related to set; Ab= absolute	Ab	Pr2

Label	Name	Range	°C/°F	Level
ALU	MAXIMUM temperature alarm	Set±110.0°C; Set±230°F	110	Pr1
ALL	Minimum temperature alarm	-50.0°C÷Set/ -58°F÷Set	-50.0	Pr1
AFH	Differential for temperat. alarm recovery	(0,1°C+25,5°C) (1°F+45°F)	1	Pr2
ALd	Temperature alarm delay	0 ÷ 255 min	15	Pr2
dAO	Delay of temperature alarm at start up	0 ÷ 23h e 50'	1.3	Pr2
AP2	Probe for temperat. alarm of condenser	nP; P1; P2; P3; P4	P4	Pr2
AL2	Condenser for low temperat. alarm	(-55 ÷ 150°C) (-67 ÷ 302°F)	-40	Pr2
AU2	Condenser for high temperat. alarm	(-55 ÷ 150°C) (-67 ÷ 302°F)	110	Pr2
AH2	Differ. for condenser temp. alar. recovery	[0,1°C + 25,5°C] [1°F + 45°F]	5	Pr2
Ad2	Condenser temperature alarm delay	0 ÷ 254 (min.) , 255=nJ	15	Pr2
dA2	Delay of cond. temper. alarm at start up	0.0 ÷ 23h 50'	1,3	Pr2
bLL	Compr. off for condenser low temperature alarm	n(0) - Y(1)	n	Pr2
AC2	Compr. off for condenser high temperature alarm	n(0) - Y(1)	n	Pr2
tbA	Alarm relay disabling	n=no; y=yes	y	Pr2
oA3	Fourth relay configuration	ALr = alarm; dEF = do not select it; Lig =Light; AUS =AUX; onF=always on; Fan= do not select it; db = do not select it; dF2 = do not select it	ALr	Pr2
AoP	Alarm relay polarity (oA3=ALr)	oP; cL	cL	Pr2
i1P	Digital input polarity	oP=opening;CL=closing	cL	Pr1
i1F	Digital input configuration	EAL, bAL, PAL, dor; dEF; Htr, AUS	dor	Pr1
did	Digital input alarm delay	0+255min	15	Pr1
Nps	Number of activation of pressure switch	0 ÷ 15	15	Pr2
odc	Compress and fan status when open door	no; Fan; CP; F_C	F-c	Pr2
rrd	Regulation restart with door open alarm	n - Y	y	Pr2
HES	Differential for Energy Saving	(-30°C+30°C) (-54°F+54°F)	0	Pr2
Hur	Current hour	0 ÷ 23	-	rtc
Min	Current minute	0 ÷ 59	-	rtc
dAY	Current day	Sun ÷ SA	-	rtc
Hd1	First weekly holiday	Sun+ SA - nu	nu	rtc
Hd2	Second weekly holiday	Sun+ SA - nu	nu	rtc
ILE	Energy Saving cycle start during workdays	0 ÷ 23h 50 min.	0	rtc
dLE	Energy Saving cycle length during workdays	0 ÷ 24h 00 min.	0	rtc
ISE	Energy Saving cycle start on holidays	0 ÷ 23h 50 min.	0	rtc
dSE	Energy Saving cycle length on holidays	0 ÷ 24h 00 min.	0	rtc
Ld1	1 st workdays defrost start	0 ÷ 23h 50 min. - nu	6.0	rtc
Ld2	2 nd workdays defrost start	0 ÷ 23h 50 min. - nu	13.0	rtc
Ld3	3 rd workdays defrost start	0 ÷ 23h 50 min. - nu	21.0	rtc
Ld4	4 th workdays defrost start	0 ÷ 23h 50 min. - nu	0.0	rtc
Ld5	5 th workdays defrost start	0 ÷ 23h 50 min. - nu	0.0	rtc
Ld6	6 th workdays defrost start	0 ÷ 23h 50 min. - nu	0.0	rtc
Sd1	1 st holiday defrost start	0 ÷ 23h 50 min. - nu	6.0	rtc
Sd2	2 nd holiday defrost start	0 ÷ 23h 50 min. - nu	13.0	rtc
Sd3	3 rd holiday defrost start	0 ÷ 23h 50 min. - nu	21.0	rtc
Sd4	4 th holiday defrost start	0 ÷ 23h 50 min. - nu	0.0	rtc
Sd5	5 th holiday defrost start	0 ÷ 23h 50 min. - nu	0.0	rtc
Sd6	6 th holiday defrost start	0 ÷ 23h 50 min. - nu	0.0	rtc
PbC	Kind of probe	Ptc; ntc	1	Pr2
Adr	Serial address	1+247	1	Pr2
onF	on/off key enabling	nu, oFF; ES	ntc	Pr1
dP1	Room probe display	--	nu	Pr2
dP2	Evaporator probe display	--	--	Pr1
dP3	Third probe display	--	--	Pr1
dP4	Fourth probe display	--	--	Pr1
rSE	Valore set operativo	actual set	--	Pr2
rEL	Software release	--	--	Pr2
Ptb	Map code	--	--	Pr2

² Only for models XR70CX--xx2xx, XR70CX--xx3xx; XR70CX--xx6xx; XR70CX--xx7xx

Dixell S.p.A. Z.I. Via dell'Industria, 27
 32010 Pieve d'Alpago (BL) ITALY
 tel. +39 - 0437 - 98 33 - fax +39 - 0437 - 98 93 13
 E-mail: dixell@dixell.com - http://www.dixell.com