

UL File No.: E122222
CSA File No.: LR39291

FEATURES

- 1. Bright and Easy-to-Read Display**
A brand new bright 2-color back light LCD display. The easy-to-read screen in any location makes checking and setting procedures a cinch.
- 2. Simple Operation**
Seesaw buttons make operating the unit even easier than before.
- 3. Short Body of only 64.5 mm 2.539 inch (screw terminal type) or 70.1 mm 2.760 inch (pin type)**
With a short body, it is easy to install in even narrow control panels.
- 4. Conforms to IP66's Weather Resistant Standards**
The water-proof panel keeps out water and dirt for reliable operation even in poor environments.

- 5. Screw terminal and Pin Type are Both Standard Options**
The two terminal types are standard options to support either front panel installation or embedded installation.
- 6. Changeable Panel Cover**
Also offers a black panel cover to meet your design considerations.
- 7. Conforms With EMC and Low Voltage Directives**
Conforms with EMC directives (EN50081-2/EN50082-2) and low-voltage directives (VDE0435/Part 2021) for CE certification vital for use in Europe.
- 8. Good performance**
All this at an affordable price to provide you with unmatched cost performance.

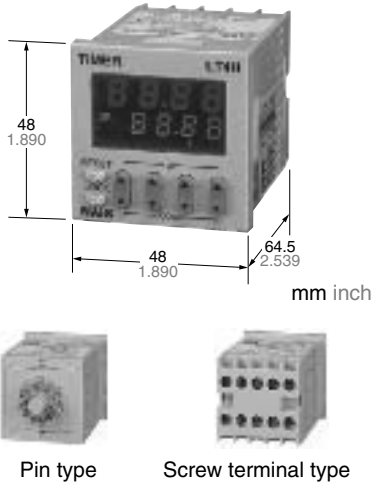

PRODUCT TYPES

Time range	Operation mode	Output	Operation voltage	Power down insurance	Terminal	Part No.
9.999 s (0.001 s~) 99.99 s (0.01 s~) 999.9 s (0.1 s~) 9999 s (1 s~) 99 min 59 s (1 s~) 999.9 min (0.1 min~) 99 h 59 min (1 min~) 999.9 h (0.1 h~)	Power ON delay (1) Power ON delay (2) Signal ON delay Signal OFF delay Pulse One-shot Pulse ON-delay Signal Flicker Totalizing ON-delay (8 modes)	Relay (1 c)	100-240 V AC	Available	8 pin	LT4H8-AC240V
					11 pin	LT4H-AC240V
					Screw	LT4H-AC240VS
					8 pin	LT4H8-AC24V
					11 pin	LT4H-AC24V
					Screw	LT4H-AC24VS
			8 pin		LT4H8-DC24V	
			11 pin		LT4H-DC24V	
			Screw		LT4H-DC24VS	
			8 pin		LT4HT8-AC240V	
			11 pin		LT4HT-AC240V	
			Screw		LT4HT-AC240VS	
	8 pin	LT4HT8-AC24V				
	11 pin	LT4HT-AC24V				
	Screw	LT4HT-AC24VS				
	8 pin	LT4HT8-DC24V				
	11 pin	LT4HT-DC24V				
	Screw	LT4HT-DC24VS				

* A rubber gasket (ATC18002) and a mounting frame (AT8-DA4) are included.

PART NAMES

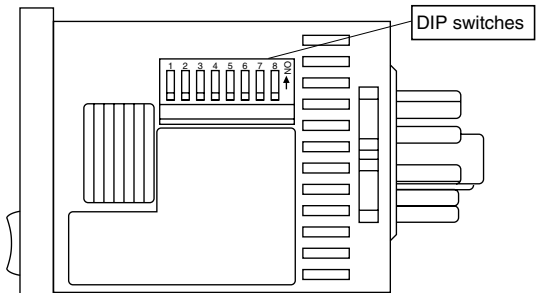
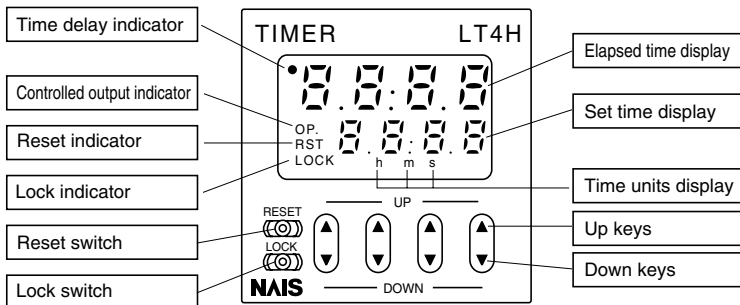

(Same for screw terminal type and 8-pin type)

SPECIFICATIONS

Item		Relay output type		Transistor output type	
		AC type	DC type	AC type	DC type
Rating	Operating voltage	100 to 240 V AC, 24 V AC ¹⁾	12 to 24 V DC	100 to 240 V AC, 24 V AC ¹⁾	12 to 24 V DC
	Frequency	50/60 Hz common		50/60 Hz common	
	Power consumption	Max. 10 V A	Max. 3 W	Max. 10 V A	Max. 3 W
	Control capacity (resistive)	5 A, 250 V AC (Resistive load)		100 mA, 30 V DC	
	Time range	9.999 s, 99.99 s, 999.9 s, 9999 s, 99 min 59 s, 999.9 min, 99 h 59 min, 999.9 h (selected by DIP switch)			
	Time counting direction	Addition (UP)/Subtraction (DOWN) (2 directions selectable by DIP switch)			
	Operation mode	A (Power ON delay 1), A2 (Power ON delay 2), B (Signal ON delay), C (Signal OFF delay), D (Pulse one-shot), E (Pulse ON delay), F (Signal Flicker), G (Totalizing ON delay) (Selectable by DIP switch)			
	Signal/Reset/Stop input	Min. input signal width: 1 ms, 20 ms (2 directions by selected by DIP switch)			
	Lock input	Min. input signal width: 20 ms			
	Input signal	Open collector input Input impedance: Max. 1 kΩ; Residual voltage: Max. 2 V Open impedance: 100kΩ or less, Max. energized voltage: 40V DC			
	Indication	7-segment LCD, Elapsed value (backlight red LED), Setting value (backlight yellow LED)			
	Power failure memory method	EEP-ROM (Min. 10 ⁵ overwriting)			
Time accuracy (max.)	Operating time fluctuation	± (0.005 % + 50 ms) in case of power on start ± (0.005 % + 20 ms) in case of reset or input signal start		[Operating voltage: 85 to 110% Temperature: -10 to +55°C +14 to +131°F Min. input signal width: 1ms]	
	Temperature error				
	Voltage error				
	Setting error				
Contact	Contact arrangement	Timed-out 1 Form C		Timed-out 1 Form A (Open collector)	
	Initial contact resistance	100 mΩ (at 1 A 6 V DC)		—	
	Contact material	Ag alloy/Au flash		—	
Life	Mechanical	2.0 × 10 ⁷ ope. (Except for switch operation parts)		—	
	Electrical	1.0 × 10 ⁵ ope. (At rated control voltage)		1.0 × 10 ⁷ ope. (At rated control voltage)	
Electrical	Operating voltage range	85 to 110 % of rated operating voltage			
	Initial breakdown voltage	2,000 Vrms for 1 min: Between live and dead metal parts (11-pin) 2,000 Vrms for 1 min: Between input and output 1,000 Vrms for 1 min: Between contacts		2,000 Vrms for 1 min: Between live and dead metal parts (Pin type) 2,000 Vrms for 1 min: Between input and output	
	Initial insulation resistance (At 500 V DC)	Min. 100 MΩ: Between live and dead metal parts Between input and output Between contacts		Min. 100 MΩ: Between live and dead metal parts Between input and output	
	Operating voltage reset time	Max. 0.5 s			
	Temperature rise	Max. 65° C (under the flow of nominal operating current at nominal voltage)			
Mechanical	Vibration resistance	Functional	10 to 55 Hz: 1 cycle/min single amplitude of 0.35 mm .014 inch (10 min on 3 axes)		
		Destructive	10 to 55 Hz: 1 cycle/min single amplitude of 0.75 mm .030 inch (1 h on 3 axes)		
	Shock resistance	Functional	Min. 98 m 321.522 ft./s ² (4 times on 3 axes)		
		Destructive	Min. 294 m 964.567 ft./s ² (5 times on 3 axes)		
Operating conditions	Ambient temperature	-10° C to 55° C +14° F to +131° F			
	Ambient humidity	Max. 85 % RH			
	Air pressure	860 to 1,060 h Pa			
	Ripple rate	—	20 % or less	—	20 % or less
Connection	8-pin/11-pin/screw terminal				
Protective construction	IP66 (front panel with rubber gasket)				

Note: 1) the 24 V AC type can be operated also with 24 V DC.

LT4H

DIMENSIONS (units: mm inch)

• LT4H digital timer

Screw-down terminal type
(embedded installation)

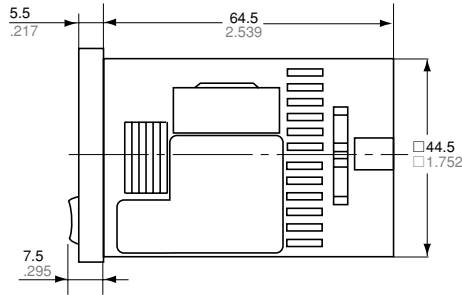
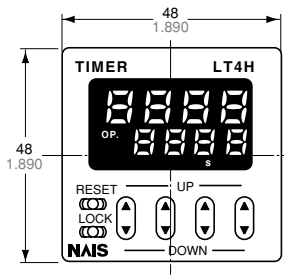

Pin type (embedded installation/
front panel installation)

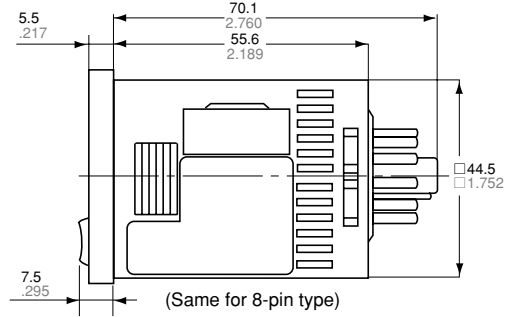

• Dimensions for embedded installation (with adapter installed)

Screw-down terminal type

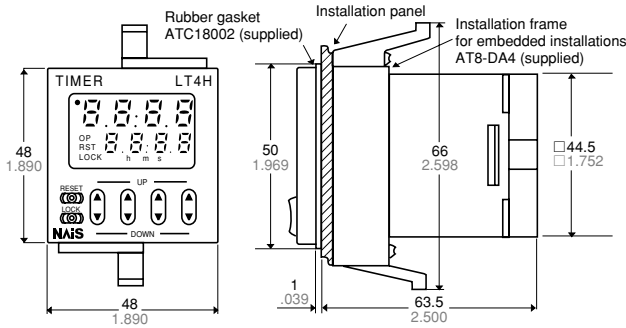

Pin type

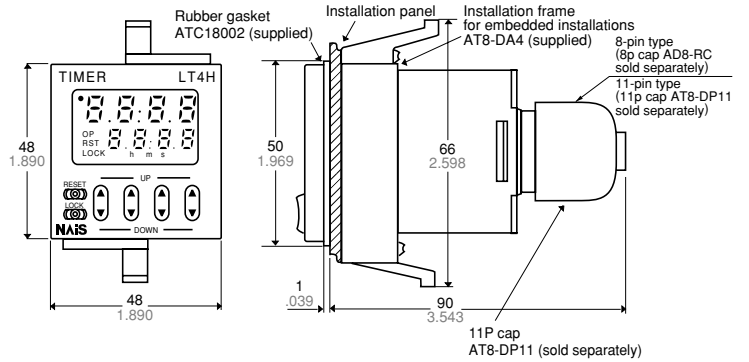

• Dimensions for front panel installations

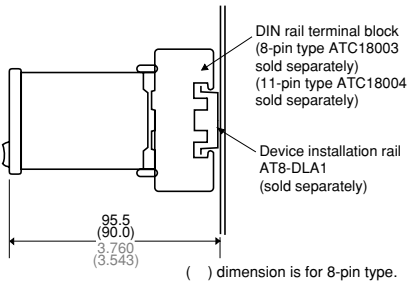

• Installation panel cut-out dimensions

The standard panel cut-out dimensions are shown below. Use the installation frame (AT8-DA4) and rubber gasket (ATC18002).

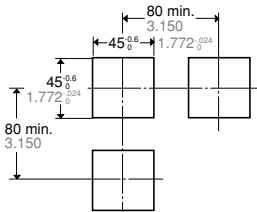

• For connected installations

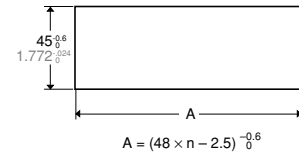

Note 1: The installation panel thickness should be between 1 and 5 mm .039 and .197 inch.

Note 2: For connected installations, the waterproofing ability between the unit and installation panel is lost.

TERMINAL LAYOUT AND WIRING

• 8-pin type

Relay output type

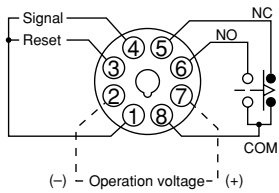

Transistor output type

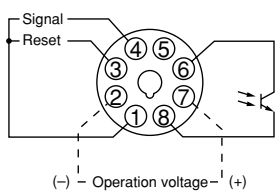

TERMINAL LAYOUT AND WIRING

• 11-pin type

Relay output type

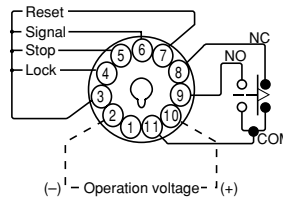

Transistor output type

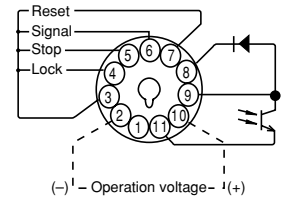

• Screw-down terminal type

Relay output type

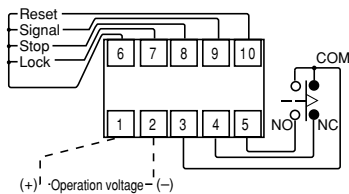

Transistor output type

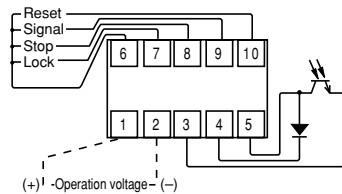

Note: For connecting the output leads of the transistor output type, refer to 5) Transistor output on page 47.

SETTING THE OPERATION MODE, TIMER RANGE, AND TIME

The new settings are valid after power OFF → ON

Setting procedure 1) Setting the operation mode and timer range

Set the operation mode and timer range with the DIP switches on the side of the unit.

DIP switches

Item	DIP switch		
	OFF	ON	
1	Refer to table 1		
2			
3			
*4	Minimum input reset, signal, and stop signal width	20 ms	1 ms
5	Time delay direction	Addition	Subtraction
6	Refer to table 2		
7			
8			

* The 8-pin type does not have the stop input, so that the dip switch can be changed over between reset and signal inputs. The signal range of the lock input is fixed (minimum 20 ms).

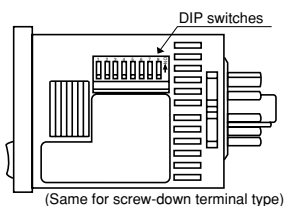

Table 1: Setting the operation mode

DIP switch No.			Operation mode
1	2	3	
ON	ON	ON	A: Power on delay 1
OFF	OFF	OFF	A2: Power on delay 2
ON	OFF	OFF	B: Signal on delay
OFF	ON	OFF	C: Signal off delay
ON	ON	OFF	D: Pulse One shot
OFF	OFF	ON	E: Pulse On delay
ON	OFF	ON	F: Signal Flicker
OFF	ON	ON	G: Totalizing On delay

Table 2: Setting the timer range

DIP switch No.			Timer range
6	7	8	
ON	ON	ON	0.001 s to 9.999 s
OFF	OFF	OFF	0.01 s to 99.99 s
ON	OFF	OFF	0.1 s to 999.9 s
OFF	ON	OFF	1 s to 9999 s
ON	ON	OFF	0 min 01 s to 99 min 59 s
OFF	OFF	ON	0.1 min to 999.9 min
ON	OFF	ON	0 h 01 min to 99 h 59 min
OFF	ON	ON	0.1 h to 999.9 h

Note: Set the DIP switches before installing the unit.

Setting procedure 2) Setting the time

Set the set time with the keys on the front of the unit.

Front display section

- ① Elapsed time display
- ② Set time display
- ③ Time delay indicator
- ④ Controlled output indicator
- ⑤ Reset indicator
- ⑥ Lock indicator
- ⑦ Time units display

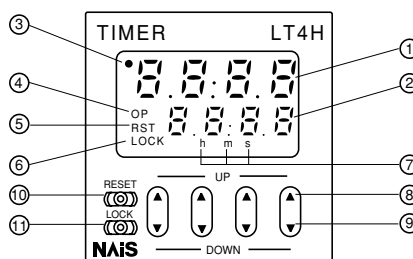

- ⑧ UP keys
Changes the corresponding digit of the set time in the addition direction (upwards)
- ⑨ DOWN keys
Changes the corresponding digit of the set time in the subtraction direction (downwards)
- ⑩ RESET switch
Resets the elapsed time and the output
- ⑪ LOCK switch
Locks the operation of all keys on the unit

• Changing the set time

1. It is possible to change the set time with the up and down keys even during time delay with the timer.

However, be aware of the following points.

1) If the set time is changed to less than the elapsed time with the time delay set to the addition direction, time delay will continue until the elapsed time reaches full scale, returns to zero, and then reaches the new set time. If the set time is changed to a time above the elapsed time, the time delay will continue until the elapsed time reaches the new set time.

2) If the time delay is set to the subtraction direction, time delay will continue until "0" regardless of the new set time.

2. If the set time is changed to "0," the unit will operate differently depending on the operation mode.

1) If the operation mode is set to A (power on delay 1) or A2 (power on delay 2), the output will turn on when the power supply is turned on. However, the output will be off while reset is being input.

2) In the other modes, the output turns on when the signal is input. When the operation mode is C (signal off delay), D (Pulse one shot), or F (Signal flicker), only when the signal input is on does the output turn on. Also, when the reset is being input, the output is off.

Operation type	Explanation	Time chart						
<p>Power on delay (1) Ⓐ</p>	<ul style="list-style-type: none"> Set the operation mode section of the DIP switches (no.'s 1, 2, and 3) on the side of the timer as shown. <table border="1" data-bbox="564 248 746 309"> <tr> <td>1</td> <td>2</td> <td>3</td> </tr> <tr> <td>ON</td> <td>ON</td> <td>ON</td> </tr> </table> Clears elapsed time value and starts time delay at power ON. After timer completion, stops at the display of the set value (addition), or stops at "0" (subtraction). Ignores signal input. Stops delay time operation at stop ON. Restarts delay time operation at stop OFF. 	1	2	3	ON	ON	ON	
1	2	3						
ON	ON	ON						
<p>Power on delay (2) Ⓐ2</p>	<ul style="list-style-type: none"> Set the operation mode section of the DIP switches (no.'s 1, 2, and 3) on the side of the timer as shown. <table border="1" data-bbox="564 714 746 775"> <tr> <td>1</td> <td>2</td> <td>3</td> </tr> <tr> <td>OFF</td> <td>OFF</td> <td>OFF</td> </tr> </table> Elapsed time value does not clear at power ON. (power outage countermeasure function) The output remains ON even after the power is cut and restarted. After timer completion, stops at the display of the set value (addition), or stops at "0" (subtraction). Ignores signal input. Stops delay time operation at stop ON. Restarts delay time operation at stop OFF. 	1	2	3	OFF	OFF	OFF	
1	2	3						
OFF	OFF	OFF						
<p>Signal on delay Ⓑ</p>	<ul style="list-style-type: none"> Set the operation mode section of the DIP switches (no.'s 1, 2, and 3) on the side of the timer as shown. <table border="1" data-bbox="564 1180 746 1240"> <tr> <td>1</td> <td>2</td> <td>3</td> </tr> <tr> <td>ON</td> <td>OFF</td> <td>OFF</td> </tr> </table> Clears elapsed time value at power ON. Time delay starts at signal ON and elapsed time value or output resets at signal OFF. Instantaneous time delay start at reset OFF and power ON while signal is ON. Stops delay time operation at stop ON. Restarts delay time operation at stop OFF. In order to have the time delay start at power ON or reset at power OFF, short out the signal input beforehand. 	1	2	3	ON	OFF	OFF	
1	2	3						
ON	OFF	OFF						
<p>Signal off delay Ⓒ</p>	<ul style="list-style-type: none"> Set the operation mode section of the DIP switches (no.'s 1, 2, and 3) on the side of the timer as shown. <table border="1" data-bbox="564 1646 746 1706"> <tr> <td>1</td> <td>2</td> <td>3</td> </tr> <tr> <td>OFF</td> <td>ON</td> <td>OFF</td> </tr> </table> Clears elapsed time value at power ON. Output control ON at signal ON and time delay start at signal OFF. Elapsed time value clears when signal goes ON again during time delay. Stops delay time operation at stop ON. Restarts delay time operation at stop OFF. 	1	2	3	OFF	ON	OFF	
1	2	3						
OFF	ON	OFF						

Notes: 1) Each signal input (signal, reset, stop, and lock) is applied by shorting their input terminal to the common terminal (terminal ① for the 8-pin type, terminal ③ for the 11-pin type, and terminal ⑥ for the screw-down terminal type).
 2) The 8-pin type does not have a stop input or lock input.

T: Set time t1, t2, t3, ta < T

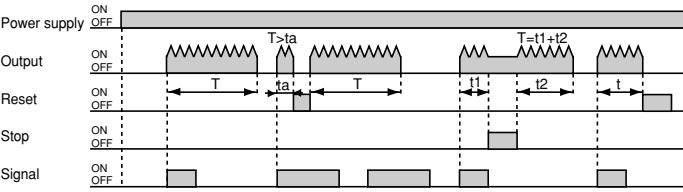
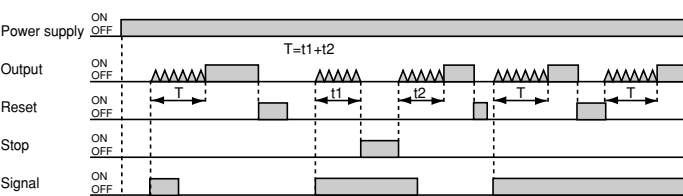
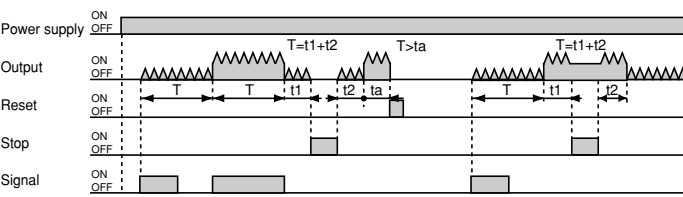
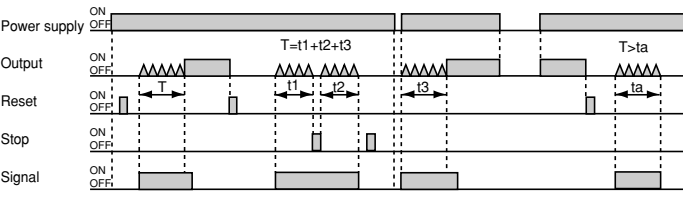
Operation type	Explanation	Time chart						
<p>Pulse One-shot Ⓓ</p>	<ul style="list-style-type: none"> Set the operation mode section of the DIP switches (no.'s 1, 2, and 3) on the side of the timer as shown. <table border="1" data-bbox="643 241 823 304"> <tr> <td>1</td> <td>2</td> <td>3</td> </tr> <tr> <td>ON</td> <td>ON</td> <td>OFF</td> </tr> </table> Clears elapsed time value at power ON. Time delay starts and output control ON at signal ON. Ignores signal input during time delay. Stops delay time operation at stop ON. Restarts delay time operation at stop OFF. 	1	2	3	ON	ON	OFF	
1	2	3						
ON	ON	OFF						
<p>Pulse On delay Ⓔ</p>	<ul style="list-style-type: none"> Set the operation mode section of the DIP switches (no.'s 1, 2, and 3) on the side of the timer as shown. <table border="1" data-bbox="643 707 823 770"> <tr> <td>1</td> <td>2</td> <td>3</td> </tr> <tr> <td>OFF</td> <td>OFF</td> <td>ON</td> </tr> </table> Clears elapsed time value at power ON. Time delay starts at signal ON. Ignores signal input during time delay. Stops delay time operation at stop ON. Restarts delay time operation at stop OFF. In order to have the time delay start at power ON or reset at power OFF, short out the signal input beforehand. 	1	2	3	OFF	OFF	ON	
1	2	3						
OFF	OFF	ON						
<p>Signal Flicker Ⓕ</p>	<ul style="list-style-type: none"> Set the operation mode section of the DIP switches (no.'s 1, 2, and 3) on the side of the timer as shown. <table border="1" data-bbox="643 1173 823 1236"> <tr> <td>1</td> <td>2</td> <td>3</td> </tr> <tr> <td>ON</td> <td>OFF</td> <td>ON</td> </tr> </table> Clears elapsed time value at power ON. Time delay starts at signal ON. Ignores signal input during time delay. Output control reverses, elapsed time value clears, and timer delay starts at timer completion. Stops delay time operation at stop ON. Restarts delay time operation at stop OFF. In order to have the time delay start at power ON or reset at power OFF, short out the signal input beforehand. 	1	2	3	ON	OFF	ON	
1	2	3						
ON	OFF	ON						
<p>Totalizing On delay Ⓖ</p>	<ul style="list-style-type: none"> Set the operation mode section of the DIP switches (no.'s 1, 2, and 3) on the side of the timer as shown. <table border="1" data-bbox="643 1639 823 1702"> <tr> <td>1</td> <td>2</td> <td>3</td> </tr> <tr> <td>OFF</td> <td>ON</td> <td>ON</td> </tr> </table> Elapsed time value does not clear at power ON. (power outage countermeasure function) The output remains ON even after the power is cut and restarted. Stops delay time operation at stop ON. Restarts delay time operation at stop OFF. 	1	2	3	OFF	ON	ON	
1	2	3						
OFF	ON	ON						

Notes: 1) Each signal input (signal, reset, stop, and lock) is applied by shorting their input terminal to the common terminal (terminal ① for the 8-pin type, terminal ③ for the 11-pin type, and terminal ⑥ for the screw-down terminal type).
2) The 8-pin type does not have a stop input or lock input.

LT4H series CAUTIONS FOR USE

PRECAUTIONS DURING USAGE

1. Terminal wiring

1) When wiring the terminals, refer to the terminal layout and wiring diagrams and be sure to perform the wiring properly without errors.

2) When using the instrument with an embedded installation, the screw-down terminal type is recommended. For the pin type, use either the rear terminal block (AT8-RR) or the 8P cap (AD8-RC) for the 8-pin type, and the 11P cap (AT8-DP11) for the 11-pin type. Avoid soldering directly to the round pins on the unit.

When using the instrument with a front panel installation, use the DIN rail terminal block (ATC18003) for the 8-pin type and the DIN rail terminal block (ATC18004) for the 11-pin type.

3) After turning the unit off, make sure that any resulting induced voltage or residual voltage is not applied to power supply terminals ② through ⑦ (8-pin type) ② through ⑩ (11-pin type) or ① and ② (screw-down terminal type). (If the power supply wire is wired parallel to the high voltage wire or power wire, an induced voltage may be generated between the power supply terminals.)
4) Have the power supply voltage pass through a switch or relay so that it is applied at one time. If the power supply is applied gradually, the counting may malfunction regardless of the settings, the power supply reset may not function, or other such unpredictable occurrence may result.

2. Input connections

The power circuit has no transformer. When an input signal is fed to two or more timers at once, do not arrange the power circuit in an independent way. If the timer is powered on and off independently as shown in Fig. A, the timer's internal circuitry may get damaged. Be careful never to allow such circuitry. (Figs. A, B and C show the circuitry for the 11-pin type.)

(Fig. A)
Input contact point or transistor

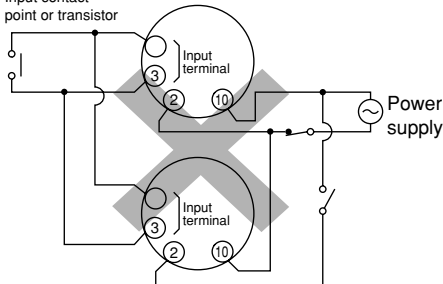

If independent power circuitry must be used, keep the input contacts or transistors separate from each other, as shown in Fig. B.

(Fig. B)

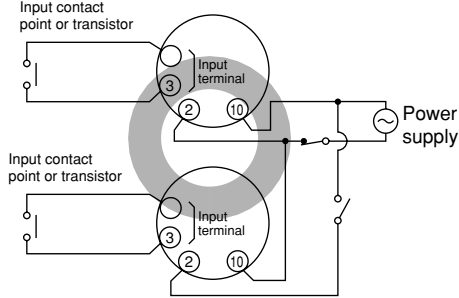

When power circuitry is not independent, one input signal can be fed to two or more counters at once, as shown in Fig. C.

(Fig. C)

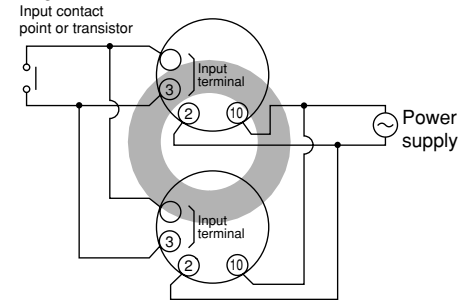

3. Input and output

1) Signal input type

(1) Contact point input

Use highly reliable metal plated contacts. Since the contact point's bounce time leads directly to error in the timer operations, use contacts with as short a bounce time as possible. Also, select a minimum input signal width of 20 ms.

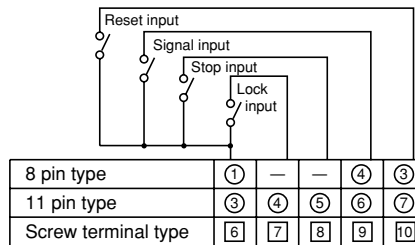

(2) Non-contact point input

Connect with an open collector. Use transistors whose characteristics satisfy the criteria given below.

$V_{CE0} = 20 \text{ V min.}$

$I_C = 20 \text{ mA min.}$

$I_{CBO} = 6 \mu\text{A max.}$

Also, use transistors with a residual voltage of less than 2 V when the transistor is on.

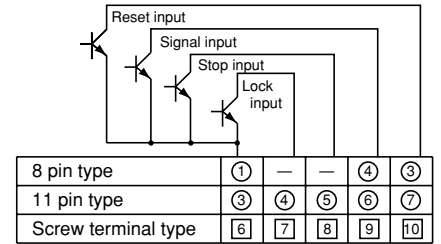

* The short-circuit impedance should be less than 1 k Ω .

[When the impedance is 0 Ω , the current coming from the input 1 and input 2 terminals is approximately 12 mA, and from the reset input and lock input terminals is approximately 1.5 mA.]

Also, the open-circuit impedance should be more than 100 k Ω .

* As shown in the diagram below, from a non-contact point circuit (proximity switches, photoelectric switches, etc.) with a power supply voltage of between 12 and 40 V, the signal can be input without using an open collector transistor. In the case of the diagram below, when the non-contact point transistor Q switches from off to on (when the signal voltage goes from high to low), the signal is input.

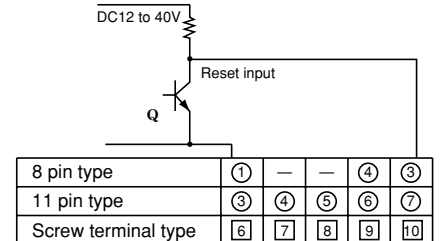

(The above example is for reset input)

2) The input mode and output mode change depending on the DIP switch settings. Therefore, before making any connections, be sure to confirm the operation mode and operation conditions currently set.

3) For the power supply of the input device, use a single-phase or double-phase insulated power transformer. The second-phase side must not be grounded.

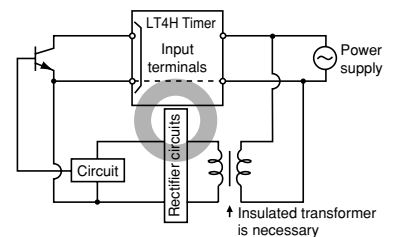

4) The input signal is applied by the shorting of each input terminal with the common terminal (terminal ① for 8-pin types, terminal ③ for 11-pin types and terminal ⑥ for screw-down terminal types). Never connect other terminals or voltages higher than DC 40 V, because it may destroy the internal circuitry.

5) Transistor output

(1) Since the transistor output is insulated from the internal circuitry by a photocoupler, it can be used as an NPN output or PNP (equal value) output. (The above example is 11-pin type)

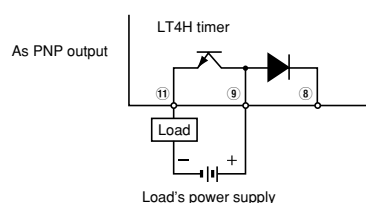
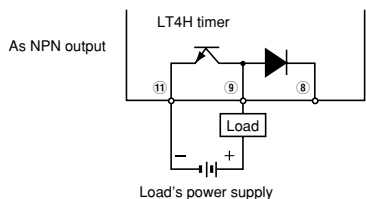

Note: With the 8-pin type, there is no diode between points ⑧ and ⑨.

(2) Use the diode connected to the output transistor's collector for absorbing the reverse voltage from induced loads.
6) When wiring, use shielded wires or

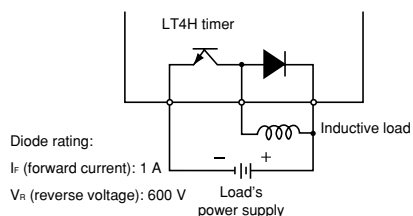

metallic wire tubes, and keep the wire lengths as short as possible.

7) For the load of the controlled output, make sure that it is lower than the rated control capacity.

8) Turning on and off the power supply while operating in A2* (Power on delay) or G (Totalizing On delay) will result in a timer error to be generated due to the characteristics of the internal circuitry. Therefore, use the signal input or stop input.

* Not related to the signal input.

9) When controlling the timer by turning on the power supply, use only A (Power on delay 1) or A2 (Power on delay 2). Use of other modes in this situation will result in timer errors. When using the other modes, control the timer with the signal input or stop input.

10) The operation mode and time range can be set with the DIP switches on the side of the timer. Make the DIP switch settings before installing the timer on the panel.

4. Conditions of usage

- 1) Avoid locations subject to flammable or corrosive gases, excessive dust, oil, vibrations, or excessive shocks.
- 2) Since the cover of the unit is made of polycarbonate resin, avoid contact with or use in environments containing methyl alcohol, benzene, thinners, and other organic solvents; and ammonia, caustic sodas, and other alkaline substances.
- 3) If power supply surges exceed the values given below, the internal circuits may become damaged. Be sure to use surge absorbing element to prevent this from happening.

Operating voltage	Surge voltage (peak value)
AC type	6,000V
DC type 24V AC type	1,000V

• Surge wave form

[± (1.2 × 50) μs uni-polar full wave voltage]

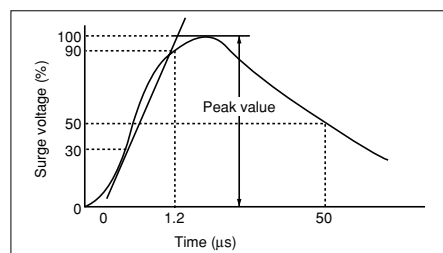

4) Regarding external noise, the values below are considered the noise-resistant voltages. If voltages rise above these values, malfunctions or damage to the internal circuitry may result, so take the necessary precautions.

	Power supply terminals		Input terminals
	AC type	DC type 24V AC type	
Noise voltage	1,500V	1,000V	600V

Noise wave form (noise simulator)

Rise time: 1 ns

Pulse width: 1 μs, 50 ns

Polarity: ±

Cycle: 100 cycles/second

5) When connecting the operation power supply, make sure that no leakage current enters the counter. For example, when performing contact protection, if set up like that of diagram A, leaking current will pass through C and R, enter the unit, and cause incorrect operation. Diagram B shows the correct setup.

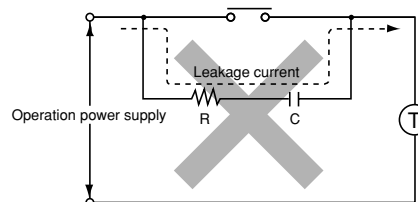

(Fig. A)

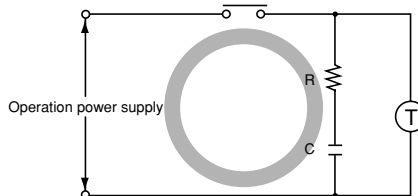

(Fig. B)

6) Long periods of continuous operation in the count-up completed condition (one month or more) will result in the weakening of the internal electrical components from the generated heat and, therefore, should be avoided. If you do plan to use the unit for such continuous operation, use in conjunction with a relay as shown in the circuit in the diagram below.

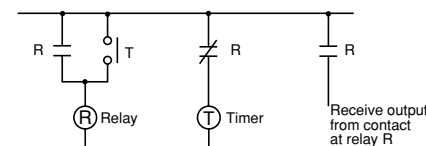

5. Self-diagnosis function

If a malfunction occurs, one of the following displays will appear.

Display	Contents	Output condition	Restoration procedure	Preset values after restoration
Et-00	Malfunctioning CPU.	OFF	Enter reset, RESET key, or restart unit.	The values at start-up before the CPU malfunction occurred.
Et-01	Malfunctioning memory. See note.			0

Note: Includes the possibility that the EEPROM's life has expired.